



STANDARD PRODUCT BROCHURE



14 Textile Crescent Salisbury Qld 4107
Ph: (07) 3277 9276 - Fax: (07) 3277 9278
Email: brian@metalwholesalers.com.au

Metal Wholesalers Product Brouchure
Contents

Angle	Light Wall	Page 1
Angle	Heavy Wall	Page 2
Channel		Page 3
Flat Bar		Page 4
Flat Bar Continue		Page 5
Rectangular Box		Page 6
Round Tube		Page 7
Round Tube Continue		Page 8
Square Box		Page 9
Tee Sections		Page 10
Aluminium Sheet		Page 11
Treadplate 5 Bar		Page 12
Work Planks		Page 13
Seat Sections		Page 14
Miscellaneous		Page 15
Miscellaneous Continue		Page 16
Miscellaneous Drawings		Page 17
Miscellaneous Drawings		Page 18
Glazing Handrail		Page 19
Louvre Sections		Page 20
Toilet Partition		Page 21

ANGLE

ITEM CODE	DESCRIPTION	MASS/MT	AP	LENGTH	FINISH
AN121216	12x12x1.6	0.097	100	6.5	Mill C/Anod
AN201216	20x12x1.6	0.131	100	6.5	Mill C/Anod
AN202016	20x20x1.6	0.167	100	6.5	Mill C/Anod
AN251216	25x12x1.6	0.153	100	6.5	Mill C/Anod
AN252016	25x20x1.6	0.187	100	6.5	Mill C/Anod
AN252516	25x25x1.6	0.21	100	6.5	Mill C/Anod
AN322016	32x20x1.6	0.218	100	6.5	Mill C/Anod
AN323216	32x32x1.6	0.271	128	6.5	Mill C/Anod
AN401216	40x12x1.6	0.218	104	6.5	Mill C/Anod
AN402016	40x20x1.6	0.253	120	6.5	Mill C/Anod
AN402516	40x25x1.6	0.274	130	6.5	Mill C/Anod
AN404016	40x40x1.6	0.34	160	6.5	Mill C/Anod
AN502516	50x25x1.6	0.318	150	6.5	Mill C/Anod
AN505016	50x50x1.6	0.427	200	6.5	Mill C/Anod

NB: Please contact us for prices

Please enquire for Non stock lines or Powdercoat lines

ANGLE

ITEM CODE	DESCRIPTION	MASS/MT	AP	LENGTH	FINISH
AN16163	16x16x3	0.236	100	6.5	Mill C/Anod
AN20203	20x20x3	0.301	100	6.5	Mill C/Anod
AN25123	25x12x3	0.275	100	6.5	Mill C/Anod
AN25203	25x20x3	0.34	100	6.5	Mill C/Anod
AN25253	25x25x3	0.382	100	6.5	Mill C/Anod
AN32203	32x20x3	0.398	100	6.5	Mill C/Anod
AN32323	32x32x3	0.496	128	6.5	Mill C/Anod
AN40203	40x20x3	0.463	120	6.5	Mill C/Anod
AN40253	40x25x3	0.502	130	6.5	Mill C/Anod
AN40403	40x40x3	0.626	160	6.5	Mill C/Anod
AN50253	50x25x3	0.583	150	6.5	Mill C/Anod
AN50503	50x50x3	0.786	200	6.5	Mill C/Anod
AN50506	50x50x6	1.528	200	6.5	Mill C/Anod
AN100506	100x50x6	2.341	300	6.5	Mill C/Anod

NB: Please contact us for prices

Please enquire for Non stock lines or Powdercoat items

CHANNEL

ITEM CODE	DESCRIPTION	MASS/MT	AP	LENGTH	FINISH
AC101016	10x10x1.6	0.116	100	6.5	Mill C/Anod
AC121216	12x12x1.6	0.142	100	6.5	Mill C/Anod
AC202016	20x20x1.6	0.246	100	6.5	Mill C/Anod
AC20203	20x20x3	0.488	100	6.5	Mill C/Anod
AC252016	25x20x1.6	0.303	100	6.5	Mill C/Anod
AC252516	25x25x1.6	0.31	147	6.5	Mill C/Anod
AC25253	25x25x3	0.561	144	6.5	Mill C/Anod
AC32253	32x25x3	0.618	158	6.5	Mill C/Anod
AC40253	40x25x3	0.683	174	6.5	Mill C/Anod
AC50253	50x25x3	0.761	194	6.5	Mill C/Anod
AC50503	50x50x3	1.171	300	6.5	Mill C/Anod

NB: Please contact us for prices

Please enquire for Non stock lines or Powdercoat items

FLAT BAR

ITEM CODE	DESCRIPTION	MASS/MT	AP	LENGTH	FINISH
AF103	10x3	0.081	100	4	Mill C/Anod
AF123	12x3	0.098	100	4	Mill C/Anod
AF163	16x3	0.13	100	4	Mill C/Anod
AF2016	20x1.6	0.086	100	4	Mill C/Anod
AF203	20x3	0.163	100	4	Mill C/Anod
AF2516	25x1.6	0.108	100	4	Mill C/Anod
AF253	25x3	0.203	100	4	Mill C/Anod
AF256	25x6	0.405	100	4	Mill
AF323	32x3	0.26	100	4	Mill C/Anod
AF326	32x6	0.518	100	4	Mill
AF363	36x3	0.293	100	4	Mill C/Anod
AF3816	38x1.6	0.165	100	4	Mill C/Anod
AF4016	40x1.6	0.173	100	4	Mill C/Anod
AF403	40x3	0.325	100	4	Mill C/Anod
AF406	40x6	0.648	100	4	Mill

NB: Please contact us for prices

Please enquire for Non stock lines or Powdercoat items

FLAT BAR

ITEM CODE	DESCRIPTION	MASS/MT	AP	LENGTH	FINISH
AF5016	50x1.6	0.217	104	4	Mill C/Anod
AF503	50x3	0.407	106	4	Mill C/Anod
AF506	50x6	0.81	112	4	Mill C/Anod
AF5010	50x10	1.355	120	4	Mill
AF803	80x3	0.648	166	4	Mill C/Anod
AF806	80x6	1.301	172	4	Mill
AF8010	80x10	2.169	180	4	Mill
AF10016	100x1.6	0.434	204	4	Mill C/Anod
AF1003	100x3	0.813	206	4	Mill C/Anod
AF1006	100x6	1.62	212	4	Mill
AF10010	100x10	2.7	220	4	Mill
AF12516	125x1.6	0.542	250	4	Mill C/Anod
AF15016	150x1.6	0.65	300	4	Mill C/Anod

NB: Please contact us for prices

Please enquire for Non stock lines or Powdercoat items

RECTANGULAR BOX

ITEM CODE	DESCRIPTION	MASS/MT	AP	LENGTH	FINISH
ARR382515	38x25x1.5 Rad Ext Rad 3mm	0.473	121	2475	Mill
				3	Mill
				6	Mill
AR402525	40x25x2.5	0.81	130	6.5	Mill
AR502516	50x25x1.6	0.624	150	6.5	Mill
AR50253	50x25x3	1.123	150	6.5	Mill
ARB50253	50x25x3 Rad	1.104	145	6.5	Mill
ARR651612	65x16x1.2 Rad	0.498	162	6	Mill
ARR651614	65x16x1.4 Rad	0.578	162	6	Mill
AR60403	60x40x3	1.53	200	6.5	Mill
AR76225424	76.2x25.4x2.4	1.274	203	6.5	Mill
AR80403	80x40x3	1.847	240	6.5	Mill
AR80503	80x50x3	2.018	260	6.5	Mill
AR1005016	100x50x1.6	1.268	300	6.5	Mill
AR100503	100x50x3	2.332	300	6.5	Mill
ARR100503	100x50x3 Rad	2.344	300	6.5	Mill
AR150503	150x50x3	3.14	400	6.5	Mill
AR200503	200x50x3	3.953	500	6.5	Mill

NB: Please contact us for prices
Please enquire for Non stock lines or Powdercoat items

ROUND TUBE

ITEM CODE	DESCRIPTION	MASS/MT	AP	LENGTH	FINISH
AT1588122	15.88x1.22	0.149	100	6.1mt	Mill
AT1588142	15.88x1.42	0.175	100	1.195 6.1	Mill Mill
AT158816	15.88x1.6	0.195	100	1.195 6.1	Mill Mill
AT1612	16x1.2	0.151	100	1.195 2.45 6.1	Mill Mill Mill
AT1912	19x1.2	0.182	100	1.195 1.495 6.1	Mill Mill Mill
AT2016	20x1.6	0.251	100	6.5	Mill
AT2516	25x1.6	0.318	100	6.5	Mill
AT253	25x3	0.56	100	6.5	Mill C/Anod
AT3216	32x1.6	0.413	101	6.5	Mill C/Anod
AT323	32x3	0.741	101	6.5	Mill
AT4016	40x1.6	0.521	126	6.5	Mill C/Anod
AT402	40x2	0.647	126	6.5	Mill
AT4025	40x2.5	0.799	126	6.5	Mill
AT403	40x3	0.945	126	6.5	Mill
AT5016	50x1.6	0.66	157	6.5	Mill

NB: Please contact us for prices
Please enquire for Non stock lines or Powdercoat items

ROUND TUBE

ITEM CODE	DESCRIPTION	MASS/MT	AP	LENGTH	FINISH
AT502	50x2	0.814	157	6.5	Mill
AT503	50x3	1.196	157	6.5	Mill
AT504	50x4	1.568	157	6.5	Mill
AT602	60x2	0.984	189	6.5	Mill
AT603	60x3	1.45	189	6.5	Mill
AT803	80x3	1.967	251	6.5	Mill
AT1002	100x2	1.67	314	6.5	Mill

NB: Please contact us for prices

Please enquire for Non stock lines or Powdercoat items

SQUARE BOX

ITEM CODE	DESCRIPTION	MASS/MT	AP	LENGTH	FINISH
AS121216	12.7x12.7x1.65	0.198	100	6.5	Mill
ASR191912	19x19x1.2 Rad	0.225	100	6.5	Mill
AS191912	19x19x1.2	0.231	100	6.5	Mill
AS191916	19x19x1.6	0.312	100	6.5	Mill
AS20202	20x20x2	0.389	100	6.5	Mill
AS252512	25x25x1.2	0.321	100	6.5	Mill
AS252516	25x25x1.6	0.406	100	6.5	Mill
ASR25252	25x25x2 Rad	0.497	100	6.5	Mill
AS25253	25x25x3	0.716	100	6.5	Mill
ASR25253	25x25x3 Rad	0.715	100	6.5	Mill
AS383816	38x38x1.6	0.659	152	6.5	Mill
AS404016	40x40x1.6	0.664	160	6.5	Mill
AS404016	40x40x1.6	0.661	160	6.5	Mill
ASR40402	40x40x2 Rad	0.825	160	6.5	Mill
AS40403	40x40x3	1.2	160	6.5	Mill
AS454516	45x45x1.6	0.78	180	6.5	Mill C/Anod
AS505016	50x50x1.6	0.839	200	6.5	Mill
ASR505016	50x50x1.6 Rad	0.801	200	6.5	Mill
ASR50502	50x50x2 Rad	0.994	200	1.8 1.8 6.5	Mill Black Mill
AS505025	50x50x2.5	1.287	200	6.5	Mill
AS50503	50x50x3	1.528	200	6.5	Mill
ASR50503	50x50x3 Rad	1.46	200	6.5	Mill
ASR75x75x3	75x75x3 Rad	2.344	290	6.5	Mill
AS1001003	100x100x3	3.154	400	6.5	Mill

NB: Please contact us for prices

Please enquire for Non stock lines or Powdercoat items

TEE SECTIONS

ITEM CODE	DESCRIPTION	MASS/MT	AP	LENGTH	FINISH
ATE252516	25x25x1.6	0.21	100	6.5	Mill
ATE25253	25x25x3	0.382	100	6.5	Mill
ATE363612	36x36x1.2	0.235		6.5	Mill
ATE404016	40x40x`1.6	0.34	160	6.5	Mill
ATE40403	40x40x3	0.626	160	6.5	Mill

SQUARE BAR

ASB127127	12.7x12.7	0.437	100	4	Mill
-----------	-----------	-------	-----	---	------

NB: Please contact us for prices
Please enquire for Non stock lines or Powdercoat items

ALUMINIUM SHEET

ITEM CODE	DESCRIPTION	MASS/MT	ALLOY	TEMPER	FINISH
	1.2X1200X2400	9.366	5005	H34	Mill C/Anod
	1.6x1200x2400	12.488	5005	H34	Mill C/Anod
	2.0x1200x2400	15.61	5005	H34	Mill C/Anod
	2.5x1200x2400	19.512	5005	H34	Mill
	3.0x1200x2400	23.33	5005	H34	Mill C/Anod
	1.2x1200x3000	11.66	5005	H34	Mill C/Anod
	1.6x1200x3000	15.55	5005	H34	Mill C/Anod
	2.0x1200x3000	19.44	5005	H34	Mill C/Anod
	3.0x1200x3000	29.16	5005	H34	Mill C/Anod
	1.2x1200x3600	14.05	5005	H34	Mill C/Anod
	1.6x1200x3600	18.74	5005	H34	Mill C/Anod
	2.0x1200x3600	23.33	5005	H34	Mill C/Anod
	3.0x1200x3600	34.99	5005	H34	Mill C/Anod

NB: Please contact us for prices

Please enquire for Non stock lines or Powdercoated items

TREADPLATE FIVE BAR

ITEM CODE	DESCRIPTION	MASS/MT	ALLOY	TEMPER	FINISH
	1.6X1200X2400	14.4	5052	0/H14/F	Mill
	2.0x1200x2400	17.85	5052	0/H14/F	Mill
	2.5x1200x2400	22.18	5052	0/H14/F	Mill
	3.0X1200X2400	25.34	5052	0/H14/F	Mill
	4.0x1200x2400	33.98	5052	0/H14/F	Mill
	5.0x1200x2400	42.62	5052	0/H14/F	Mill
	6.0x1200x2400	49.82	5052	0/H14/F	Mill

NB: Please contact us for prices

Please enquire for Non stock lines or Powdercoat items

WORK PLANKS

ITEM CODE	DESCRIPTION	MASS/MT	AP	LENGTH	FINISH
	Work Plank Complete			3 4 5 6	Mill Mill Mill Mill
	End Cap Available Ex Mill Only				Cast
	Work Plank Extrusion Only Available Ex Mill Only			Various	Mill

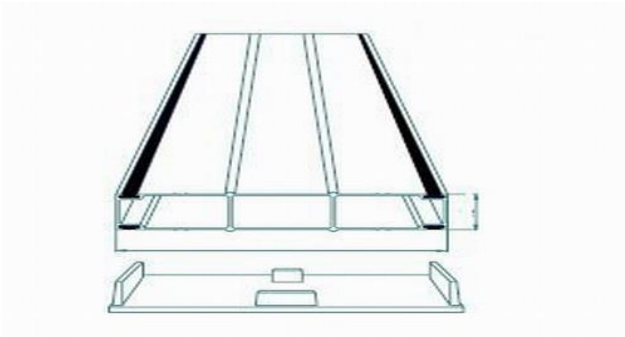

NB: Please contact us for prices
Please enquire for Non stock lines or Powdercoat items

SEAT SECTIONS

ITEM CODE	DESCRIPTION	MASS/MT	AP	LENGTH	FINISH
	Seat			6.5	Mill
	Back Rest			6.5	Mill

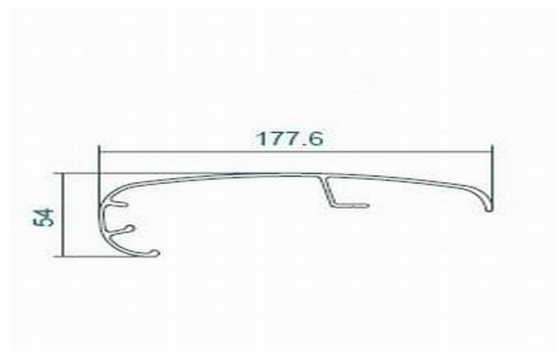
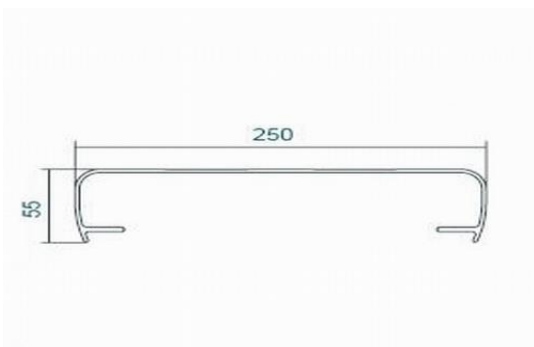

NB: Please contact us for prices
Please enquire for Non stock lines or Powdercoat items

MISCELLANEOUS

ITEM CODE	DESCRIPTION	MASS/MT	AP	LENGTH	FINISH
	Single Annexe Sail Track	0.259	100	6	Mill
	Double Sided Rope Track			6	Mill
	35mm Corner Mould			6.5	Mill
	Table Edge			6	Mill
	Table Edge			4	Mill
	Pop Up Canopy			5	Mill
	Pop Up Roof Frame			5	Mill
	Channel			6.8	Mill
	Channel			6.8	Mill
	Cover Strip			6	Mill
	Trim Angle			4	Mill
25926	Slatwall Ext	0.176	100	2.42	Mill
	Visor Mould	0.267	100	5	Mill
	Screen Surround	0.258	100	4.5	Mill C/Anod

SKIRTING SECTIONS

	50mm Skirting	0.251	131	3.66	Mill C/Anod
MW003	100mm Skirting	0.441	235	3.66	Mill C/Anod
	125mm Skirting	0.518	283	3.66	Mill C/Anod
	150mm Skirting	0.653	337	3.66	Mill C/Anod

NB: Please contact us for prices
Please enquire for Non stock lines and Powdercoating

MISCELLANEOUS

ITEM CODE	DESCRIPTION	LENGTH	FINISH
MB300	Moulded Cover Strip	300mt	Black
MG300		300mt	Grey
MB100		100mt	Black
MG100		100mt	Grey
MB50		50mt	Black
MG50		50mt	Grey
MBLM		1mt	Black
MGLM		1mt	Grey
FB500	Flat Cover Strip	500mt	Black
FG500		500mt	Grey
FB100		100mt	Black
FG100		100mt	Grey
FW100		100mt	White
FB50		50mt	Black
FB50		50mt	Grey
FBLM		1mt	Black
FGLM		1mt	Grey
FWLM		1mt	White
009BPK	Skirting Corner for 100mm Skirting	Bag/50	Black
009GPK		Bag/50	Grey
009WPK		Bag/50	White
009BEA		ea	Black
009GEA		ea	Grey
009WEA		ea	White
015BPK	Skirting Corner for 125 and 150 Skirting	Bag/50	Black
015GPK		Bag/50	Grey
015WPK		Bag/50	White
015BEA		ea	Black
015GEA		ea	Grey
015WEA		ea	White

NB: Please contact us for prices

Please enquire for Non stock lines or Powdercoat items

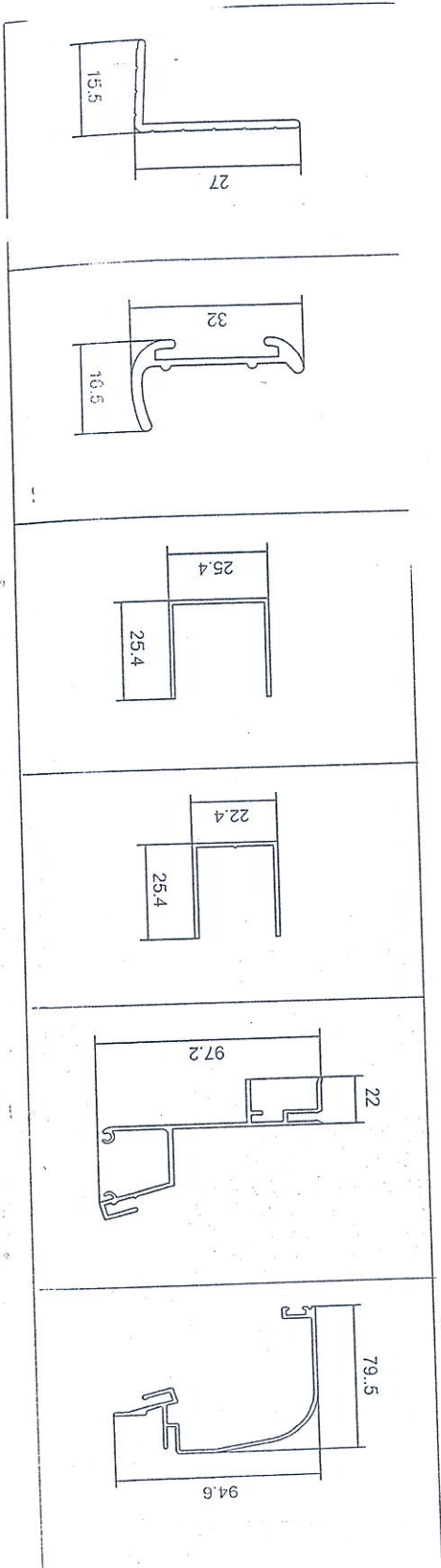
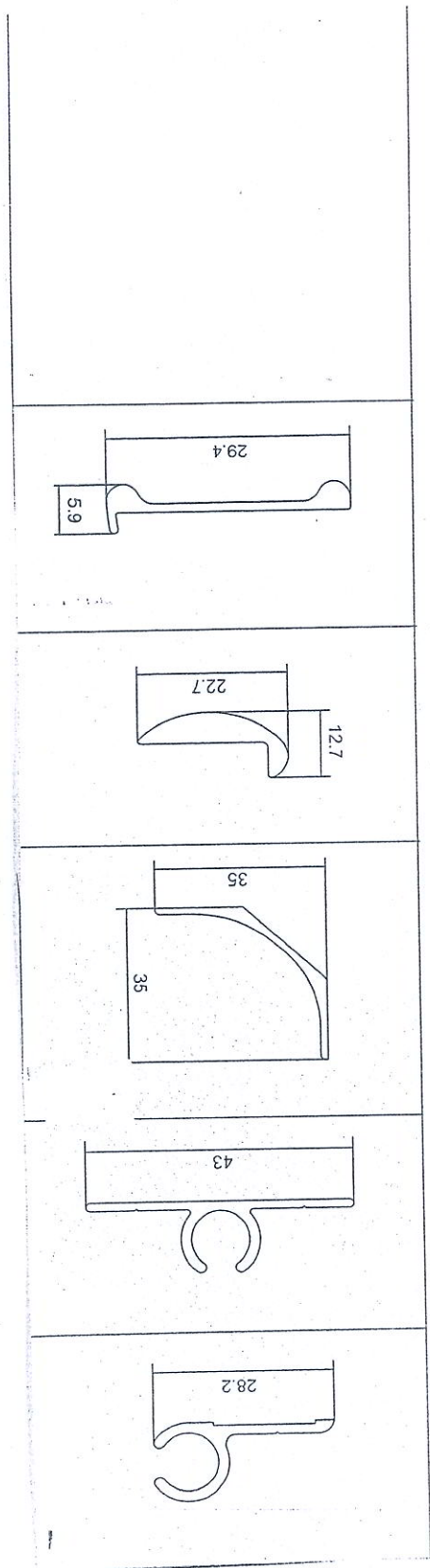

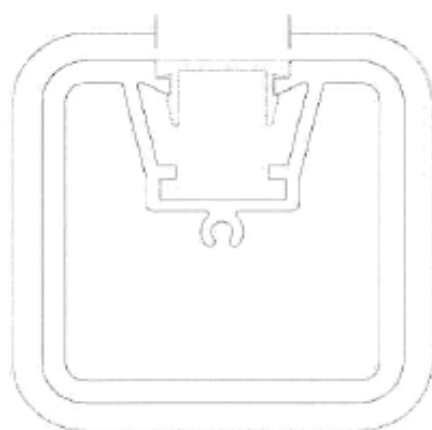
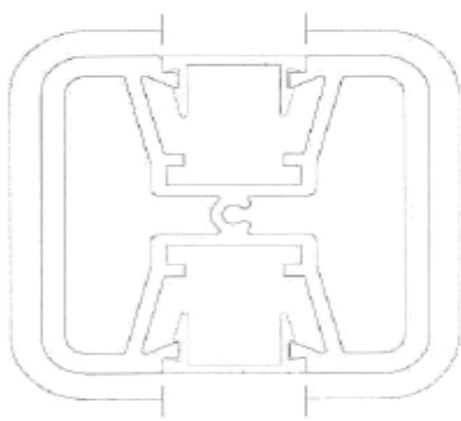
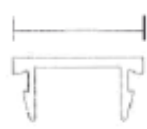

GLAZING HANDRAIL

ITEM CODE	DESCRIPTION	MASS/MT	AP	LENGTH	FINISH
	50mm Round One Way	1.662	222	6.1	Mill
	50mm Round Two Way	1.727	287	6.1	Mill
	50mm Round Three Way	1.672	339	6.1	Mill
	Round Infill	0.2	100	6.1	Mill
	50mm Square One Way	1.763	257	6.1	Mill
	50mm Square Two Way	1.995	324	6.1	Mill
	50mm Square Three Way	2.021	370	6.1	Mill
	Square Infill	0.131	100	6.1	Mill
	Oval Handrail 70x40 (Flat Bottom)	0.831		6.5	Mill

NB: Please contact us for prices
Please enquire for Non stock lines or Powdercoat items

LOUVRE SECTIONS

ITEM CODE	DESCRIPTION	MASS/MT	AP	LENGTH	FINISH
LV108	Blade 60x30	0.572	185	6.5	Mill 20um C/A
LV107	16mm Spacer Bar	0.398	100	4.0mt	Mill 20um C/A
LV106	Load Bar	0.079	100	4.0mt	Mill

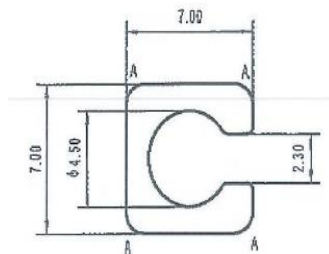
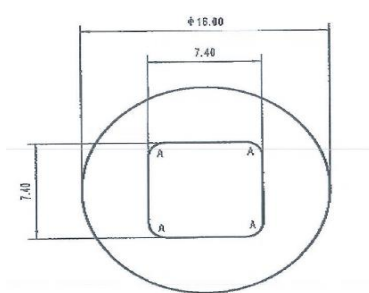
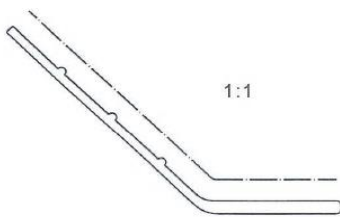

NB: Please contact us for prices
Please enquire for Non stock lines or Powdercoat items

TOILET PARTITION

ITEM CODE	DESCRIPTION	MASS/MT	AP	LENGTH	FINISH
MW 020	"H" Joiner 18mm	0.275	147	6	20um Cl
MW 021	13mm Channel	0.467	169	6	20um Cl
MW 022	Infill to suit MW021	0.143	100	6	20um Cl
MW 023	18mm Channel	0.551	206	6.15	20um Cl
MW 024	Infill to suit MW023	0.24	170	6	20um Cl
MW025	33mm Channel	0.748	233	6	20um Cl
MW026	Infill to suit MW025	0.302	199	6	20um Cl

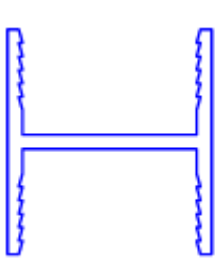

MW020

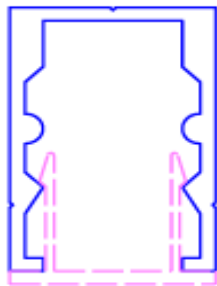

MW021

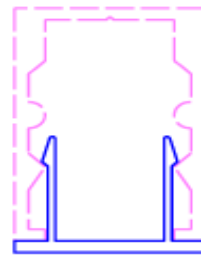

MW022

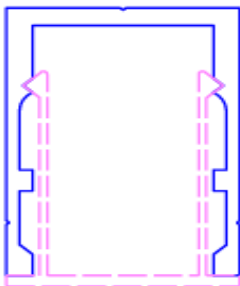

MW023

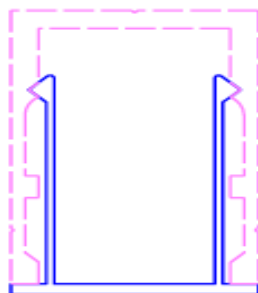

MW024

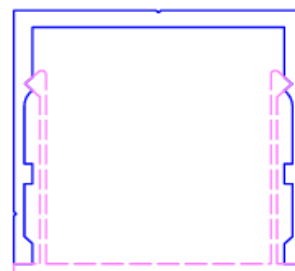

MW025

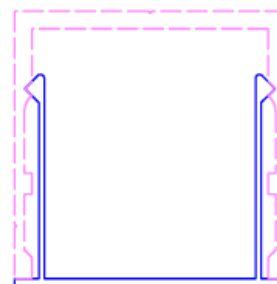

MW026

NB: Please contact us for prices
Please enquire for Non stock lines or Powdercoat items

STAINLESS PRODUCTS

ITEM CODE	DESCRIPTION	LENGTH	FINISH
ROUND TUBE			
SSRT12716	12.7x1.6	6	600 Grit
SSRT158812	15.88x1.6	6	600 Grit
SSRT25416	25.4x1.6	6	600 Grit
SSRT38116	38.1x1.6	6	600 Grit
SSRT	50.8x1.6	6	600 Grit
SQUARE BOX			
SS12712712	12.7x12.7x1.2	6	180 Grit
SS38138116	38.1x38.1x1.6	6	180 Grit
SS505016	50x50x1.6	6	180 Grit

NB: Please contact us for prices